

Fitted Sheet Folder, inside fold

Type Red Diamond

espritech GmbH • Gislaren 2 • CH-3266 Wiler bei Seedorf
Switzerland

espritech

The **Red Diamond** folding machine is for the folding and stacking of fitted sheets, flat sheets, duvet covers, curtains, blankets and other flat product - woven, non woven, non-elastic pieces.
This installation is a stand - alone unit. The folding machine is able to work up various material types including cotton, sateen, mixture fabric, polyester/cotton, and flannel.
The feeding edges of the pieces are hidden as inside fold.
The system is equipped with a cardboard inserting device for standard and book fold folding.

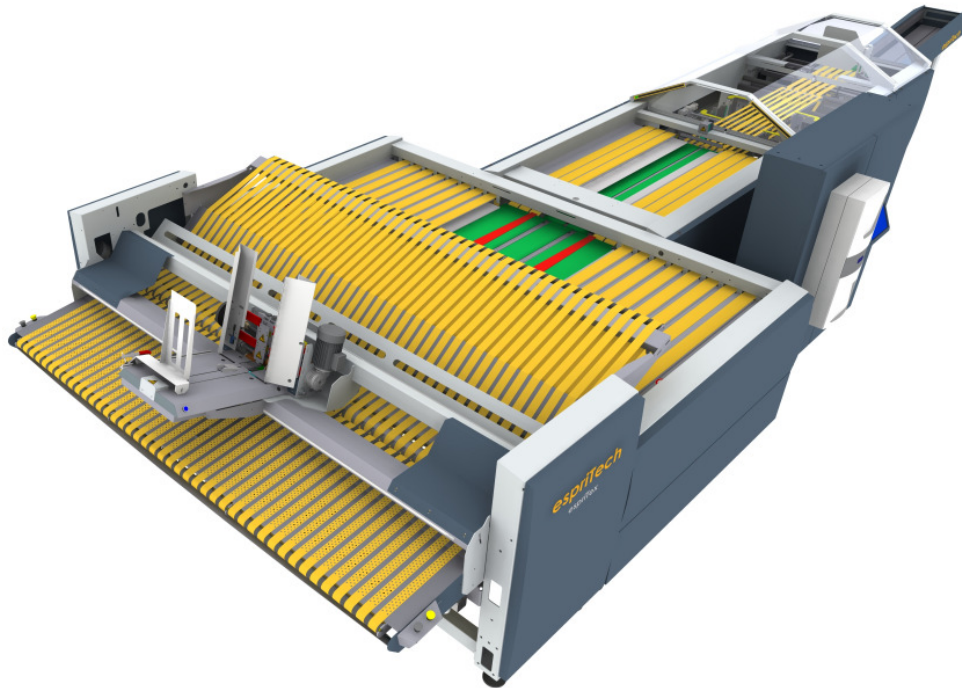

Feeding size:

(Additional Sizes on request)

- W = 40"-120" / 1000mm - 3050mm
- L = 40"-130" / 1000mm - 3300mm

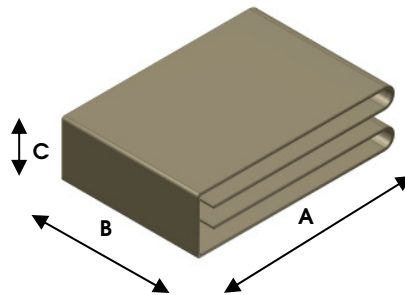

Folding size:

(Additional sizes on request)

- A = 6" - 15" / 152mm - 301mm
- B = 9" - 16" / 228mm - 406mm
- C = Gusset up to 3" / 76mm

Production:

- One operator for manual feeding
- Up to 650 pieces / h

Modules:

- In feed table
- Cross fold A (by reversing & air blast)
- Cardboard inserter
- Lateral fold A (by sliders & templates)
- Lateral fold B (by sliders & templates)
- Cross fold B (by swing arm)
- Cross fold C (Swing Arm)
- Cross fold D (reversing & folding knife)
- Stacker

Folding pattern:

- Inside fold (hidden boarder)

Book fold
Inside fold

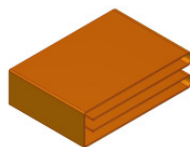
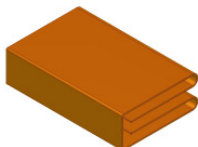

Standard fold
Inside fold

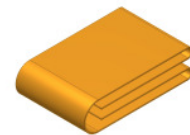
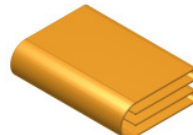

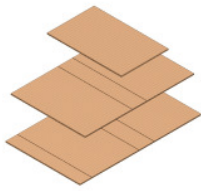

Cardboard types & sizes (Standard & book cardboard for flat sheets):

- (Additional sizes on request)
- Maximum width 381 mm/15"
 - Minimum width 222 mm/8 3/4"
 - Maximum length 698 mm/27 1/2" + height of the gusset max. 76 mm/3"
 - Minimum length 444 mm/17 1/2" + height of the gusset max. 76 mm/3"
 - Magazine load up to 405 mm (16")
- All cardboards will be folded to the very inside of the fabric, non visible

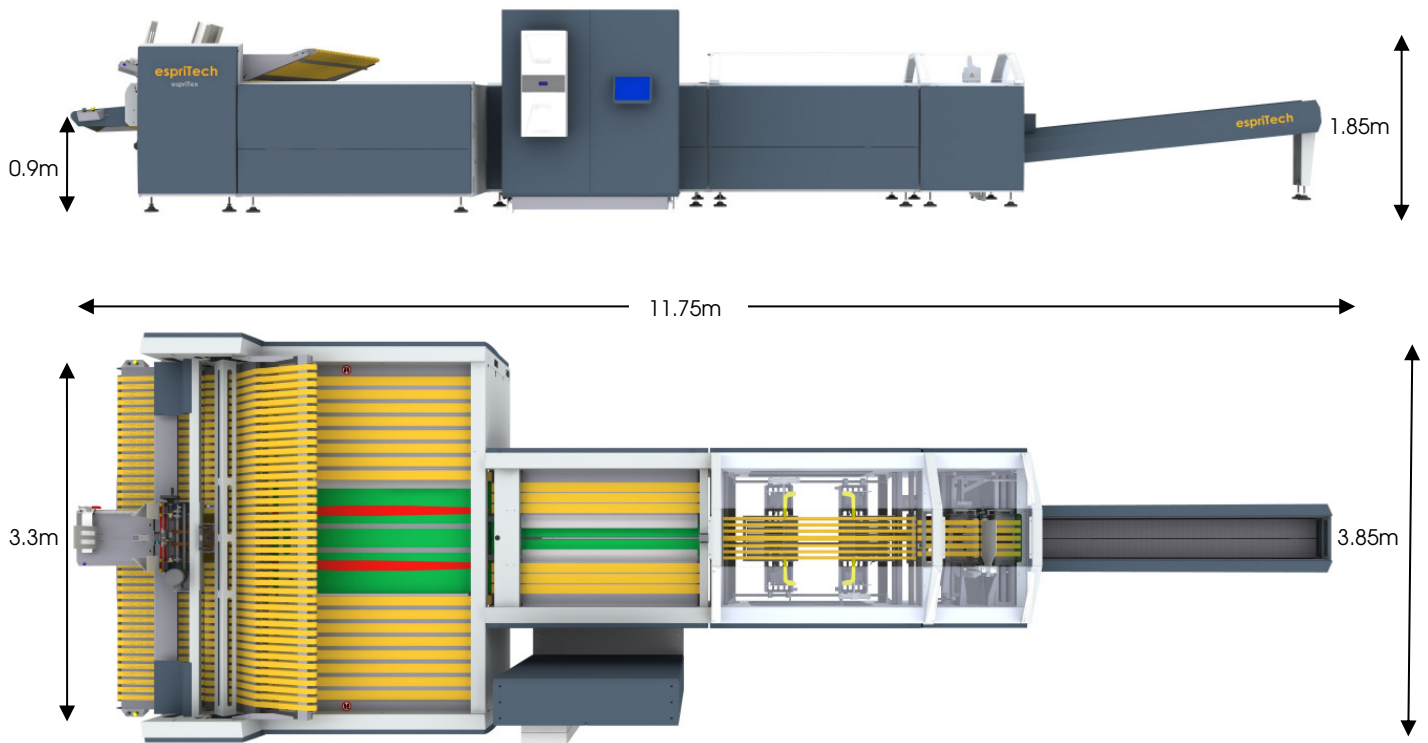

Technical data:

- 230/400V 50/60Hz, 3 phases /N/PE, approx 20A, 13 kW
- Compressed air 6Bar / 87psi
- 550 L/Min air consumption

Control system:

- Beckhoff TwinCAT, PC- Windows XP
- 15" Touchscreen
- 40'000 program spaces
- Remote access integrated (Internet)
- Integrated cooling system

Options

- Additional folding stations
- Rolloff stacking system
- Many other options on request

Business contact:

espritech

espritech GmbH
 Gisleren 2
 CH-3266 Wiler bei Seedorf
 Switzerland

www.espritech.ch
info@espritech.ch

T: +41 32 530 22 78
 F: +41 32 530 22 79

Manufactured by:

espritech

espritech GmbH
 Gisleren 2
 CH-3266 Wiler bei Seedorf
 Switzerland